

Frequency Doubler

FDZ5013/FDZ5013C

V2

Features

- Input 3 to 12 GHz
- Output 6 to 24 GHz
- Input Drive Level +13 dBm (nominal)
- Hermetically-Sealed Package

Description

The FDZ5013 is a passive bridge diode frequency doubler, designed for use in military, commercial and test equipment applications. The design utilizes Schottky bridge quad diodes and broadband soft dielectric and/or ferrite baluns to attain excellent performance. The use of high temperature solder assembly processes used internally makes it ideal for use in manual and semi-automated assembly. Environmental screening available to MIL-STD-883, MIL-STD-202, or MIL-DTL-28837, consult factory.

Ordering Information

Part Number	Package
FDZ5013	Versapac
FDZ5013C	SMA Connectorized

Product Image

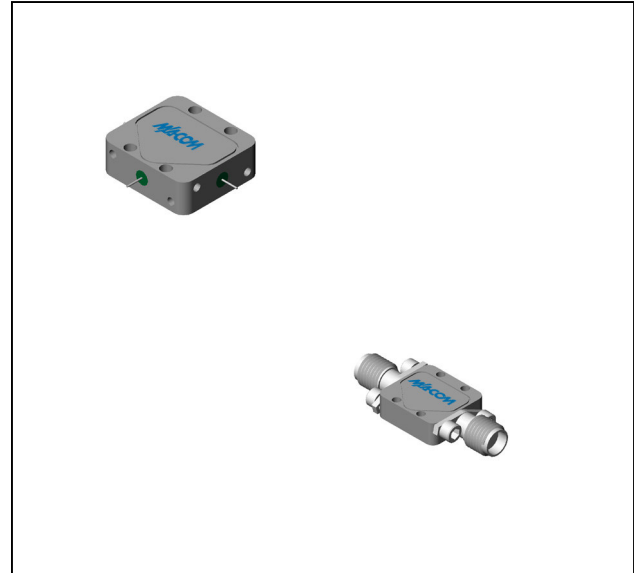

Electrical Specifications: $Z_0 = 50\Omega$ $P_{in} = +13$ dBm

Parameter	Test Conditions	Units	Typical	Guaranteed	
				+25°C	-54° to +85°C
SSB Conversion Loss (max)	$f_{in} = 3$ to 12 GHz	dB	12	14.5	15
Fundamental Suppression (min)	$f_{in} = 5$ to 8 GHz $f_{in} = 3$ to 9 GHz $f_{in} = 3$ to 12 GHz	dBc	15.0 13.0 11.0	11.0 9.5 8.0	9.0 7.5 6.0
Third Harmonic Suppression	$f_{in} = 3.0$ to 5.0 GHz $f_{in} = 5.0$ to 8.5 GHz	dBc	25 22	20 17	18 15
Input VSWR	$f_{in} = 5$ to 10 GHz $f_{in} = 3$ to 12 GHz		1.7:1 2.0:1		

Frequency Doubler

FDZ5013/FDZ5013C

V2

Typical Performance Curves

VSWR vs. Frequency

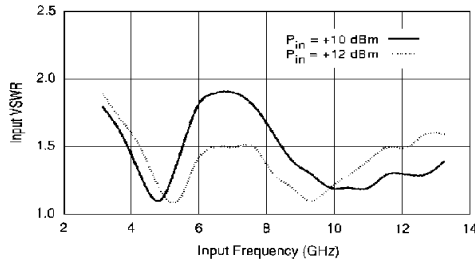

VSWR vs. Frequency

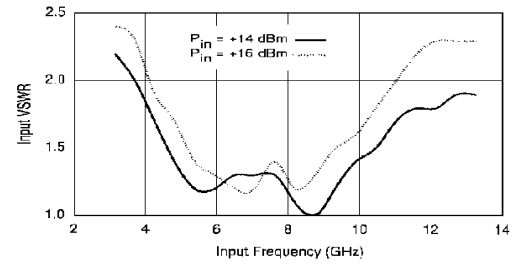

Conversion Loss vs. Frequency

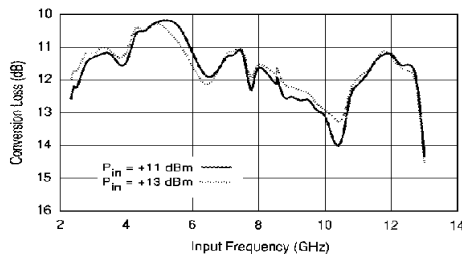

Conversion Loss vs. Frequency

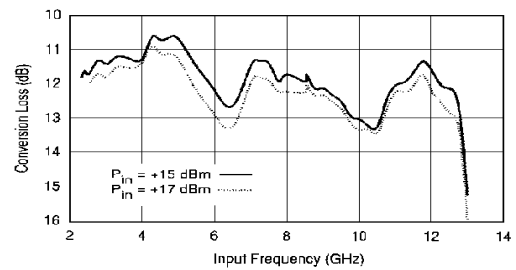

Fundamental Suppression vs. Frequency

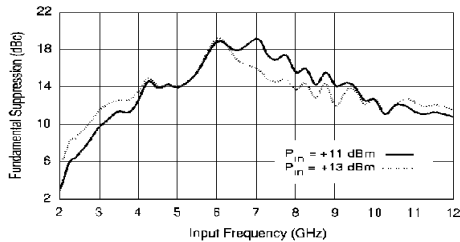

Fundamental Suppression vs. Frequency

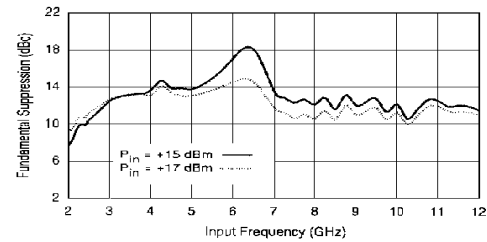

Frequency Doubler

FDZ5013/FDZ5013C

V2

Absolute Maximum Ratings

Parameter	Absolute Maximum
Operating Temperature	-54°C to +100°C
Storage Temperature	-65°C to +100°C
Peak Input Power	+23 dBm max @ +25°C +20 dBm max @ +100°C
Peak Input Current	50 mA DC

Outline Drawing: Versapac *

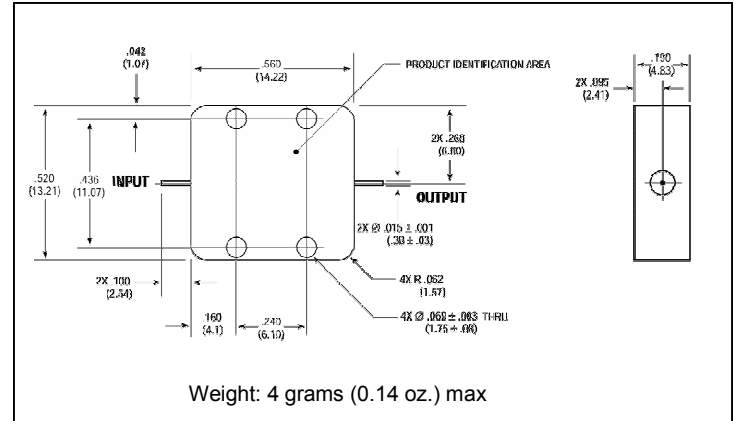

3rd Harmonic Suppression vs. Frequency

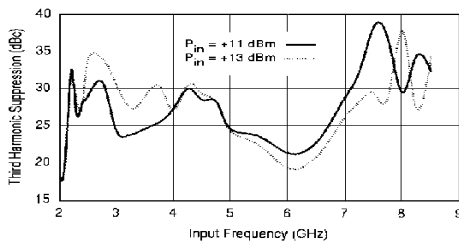

Outline Drawing: SMA Connectorized *

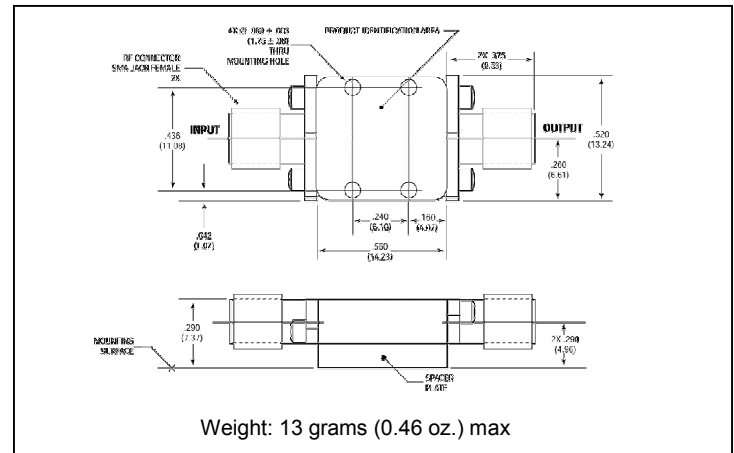

* Dimensions are inches (millimeters) ±0.015 (0.38) unless otherwise specified.